



Scanvest
The CCoIP Company

Powered by
Turbine
Technology!



ScanModul SMIP2.

Modular IP door stations – made from V4A steel.

First impressions count. When entering a building they are usually made right at the door. That's why you expect **superior performance** from a door intercom, day and night:

- excellent speech intelligibility
- crystal-clear video stream
- robust, high-quality workmanship

In addition, you want a design that is modern, clean and timeless. Top that with the ability to choose your own functional modules and it's perfect!

Our modular IP door station series ScanModul combines all these features. You can also integrate it flexibly into existing communication systems. Get an overview [here](#).

Features & modules

Modular design for maximum flexibility

Every building is different and therefore the requirements for a door intercom are always individual. While one person is satisfied with a central call button and an intercom option, another requires a clear video image and comprehensive access management at the door. Thanks to their modular design, our door intercom stations can be flexibly adapted to the respective requirements.

Turbine technology ensures outstanding audio quality

All ScanModul stations feature Turbine Technology from our partner Zenitel. Thanks to automatic volume adjustment, active noise suppression and open duplex, audio quality and speech intelligibility remain at a very high level at all times – even with loud ambient noise.

Variants & accessories

We regularly offer ScanModul in versions from 1 to 5 modules. Other frame versions and pedestals are available on request. Various frame variants made of aluminum and stainless steel are available. Powder coating in your desired RAL color is also possible.

The intercom stations are available as surface-mounted and flush-mounted versions and can be fitted with a weather protection roof if required.

Certified IPBX platforms

ScanModul works with Turbine Technology from Zenitel. The following IPBX platforms have been tested and certified by Zenitel.

- Alcatel-Lucent Communication Platform - OmniPCX Enterprise
- Asterisk configuration
- Avaya Aura CM 7.1 configuration
- Avaya Aura R8.1 platform
- Avaya Aura Session and Communication Manager
- Avaya Communication Server CS1000E
- Avaya IP Office 10.1 configuration
- Cisco Call Manager 10 configuration
- Cisco Call Manager 6 configuration
- Cisco Call Manager 8 configuration
- Cisco Unified Communications Manager, 8.6
- Cisco Unified Communications Manager, 9.1
- NEC iPBX Versions 3C/SV8300/iS3000

Certificates and configuration instructions can be found at www.wiki.zenitel.com



Audio and video modules

3096613001

AIP38901-02 Voice module TKIV+ for video

- SMIP2 voice module with VA4 front panel
- Vandal-proof IP54, IK07, DIN EN 50486; poke protection
- Powered by Turbine Technology (TKIV)
- High-end audio quality: automatic volume adjustment, noise suppression, open duplex
- Remote software upgrade, configuration and monitoring
- Power supply via PoE/alternatively 24-48VDC
- 6 configurable I/Os
- Supports numerous IP network standards

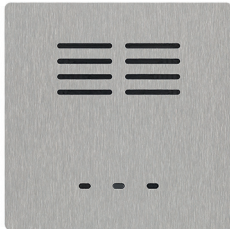

Technical specifications	
Weight	300 g
Dimensions (W x H x D)	105 x 105 x 46 mm
Operating voltage	PoE, PoE+: IEEE 802.3af , IEEE 802.3at or ext. power supply: 24-48VDC
Current/Power	Idle mode approx. 3.5 watts Voice transmission max. 12 watts
Temperature	-20 °C to + 55°C
Protection class	in flush-mounted/surface-mounted box with mounting frame VV and front panel: IP54 according to EN50629 IK07 according to EN62262 Vandalism-protected in accordance with DIN EN 50486
Material	V4A front panel, Aluminum frame
Ports	Ethernet: RJ45 10Base-T/100Base-TX, PoE Relay: potential-free, NO/NC contact I/O: 6x configurable as input or output Outputs: up to 6x; 12mA for LED control
Loudspeaker	8 Ohm, ø50 mm, 0,3 - 10 kHz
Microphone	Elektret, Omnidirectional, 0,3 - 18 kHz, 50 DB
DTMF	RFC 2833 (Outband), RFC2976 (SIP-Info)
Protocols	IPv4 (with DiffServ), SIP, TCP, UDP, HTTPS, TFTP, RTP, RTSP, RTCP, SRTP, DHCP, SNMP, Vingtor-Stentofon CCoIP®, NTP, ONVIF, WS-Discovery
Audiocodex	G.711, G.722, G.729
Management & Operation	HTTP/HTTPS (web configuration) DHCP and static IP address assignment, remote software upgrade, central monitoring



3096613002

AIP38931-03 Camera module TKIV+

- SMIP2 camera module with VA4 front panel
- HD video with up to 30 fps in 1440 x 1080p
- Light sensitivity down to less than 1 lux
- Wide-angle lens
- Viewing angle: horizontal=145°, vertical=109°
- ONVIF-Profile S compliant
- MJPEG, H.264
- Can only be used with AIP38901-02 Voice module

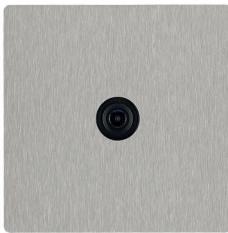

Technical specifications	
Weight	250 g
Dimensions (W x H x D)	105 x 105 x 46 mm
Operating voltage	Versorgung über Sprachmodul TKIV+
Current/Power	Versorgung über Sprachmodul TKIV+
Temperature	-20° C to + 55° C
Protection class	IP54
Material	V4A front panel, Aluminum frame
Sensor	1/2.5" RGB CMOS
Resolution (pixels)	240 / 480p / 960x720p / 1440x1080p
FPS	30 bei 1440 x 1080p
Lens	F 2.0, fixed aperture
Parallel video streams	6 (1x SIP H.264, 2x HTTP MJPEG, 3x RTSP Sessions)
Aperture angle	horizontal=145°, vertical=109°
Compression	MJPEG, H.264
Light sensitivity	down to less than 1 lux
ONVIF	ONVIF Profile S

3096613026

AIP38908-02 Voice module TKIS1

- SMIP2 voice module with VA4 front panel
- Vandal-proof IP54, IK07, DIN EN 50486, poke protection
- Powered by Turbine Technology (TKIS)
- High-end audio quality: automatic volume adjustment, noise suppression, open duplex
- Integrated 2-color LED call status display
- Remote software upgrade, configuration and monitoring
- Power supply via PoE/alternative 24VDC
- Supports numerous IP network standards
- **Ideal if the IP camera is connected separately or no camera is required**



Technical specifications	
Weight	ca. 400 g
Dimensions (W x H x D)	105 x 105 x 47 mm
Operating voltage	PoE compatible (end span only), class 0 Or power supply: 24 V DC
Current/Power	Idle mode approx. 3.5 watts Voice transmission max. 12 watts
Temperature	-20 °C to + 55°C
Protection class	Vandalism-protected IP54, IK07, DIN EN 50486; poke protection
Material	V4A front panel, Aluminum frame
Ports	Ethernet: 1 x RJ45 I/O: 4x digital input for call buttons Relay output: 24V / 2A potential-free +5V output 200 mA for button illumination LED output for integrated call status display (red/green, on IO5 und IO6)
Built-in amplifier	Digital, built-in loudspeaker 2W
Microphone	Built-in electret microphone
DTMF	RFC 2833 (Outband), RFC2976 (SIP-Info)
Protocols	IPv4 (with DiffServ), SIP, TCP, UDP, HTTPS, TFTP, RTP, RTSP, RTCP, SRTP, DHCP, SNMP, Vingtor-Stentofon CCoIP®, NTP, ONVIF, WS-Discovery
Audiocodex	G.711, G.722, G.729

3096613027

AIP38905-02 Voice module TKIS2

- SMIP2 voice module with VA4 front panel
- Ideal if an IP camera (camera module TKIS, camera module dome) is operated on the same network line and the **camera module TKIV+ cannot be used**

Technical specifications	
same as AIP38908-02 Voice module TKIS1 + additionally:	
Ports	Relay output 1 as NO or NC Relay output 2 as NO Internal switch with network output for connecting an IP camera Outputs 12V DC or 48V DC for supplying an IP camera Outputs IO1 to IO4 for call-button modules Outputs IO5 and IO6 used internally for call status display and relay 2

3096613020

AIP38932-03 Camera module TKIS

- SMIP2 camera module with V4A front panel
- Resolution max. 1920 x 1080px, max. 8 streams
- Auto switching IR filter
- IR field of view illumination for optimum day/night vision
- Stainless steel bezel
- Connection cables for connection to TKIS voice module
- 12V DC supply via voice module
- Network connection via switch integrated in the TKIS voice module
- RTSP and ONVIF



Technical specifications

Weight	250 g
Dimensions (W x H x D)	105 x 105 mm
Power supply	DC 12 Volt / 3 Watt max.
Alternative power supply	Optional: PoE, DC 15..60 VDC
Temperature	-20°C bis + 55°
Protection class	IP54
Material	V4A front panel, Aluminum frame
Sensor	1/2.9" S03 + Hisilicon 3516EV200
Resolution (Pixel)	max. 1920x1080 / 1024x768 / 704x576 / 640x512 / 640x360 / 320x240 / max. 8 streams / bit rate limitation adjustable
FPS	25 / (30) at 1920x1080 (other)
Lens	M12x0.5 / f=2.8mm / F1.8 / xfocus without IR filter, other focal lengths possible on request
Parallel video streams	8 Streams and single image retrieval
Aperture angle	With standard lens: 125° horizontal / 80° vertical / 136° diagonal
Compression	H.264 (Baseline, Main und High Profile) and MJPEG
Light sensitivity	0.1 Lux (Color) / 0.01 Lux (B/W)
ONVIF	ONVIF 2.42

3096613023

AIP38906-02 Voice module TKIE1-ST

- SMIP2 voice module with VA4 front panel
- Vandal-proof IP54, IK07, DIN EN 50486; poke protection
- Powered by Turbine Technology (TKIE)
- High-end audio quality: automatic volume adjustment, noise suppression, open duplex
- Integrated 2-color LED call status display
- Remote software upgrade, configuration and monitoring
- Power supply via PoE/alternatively 24VDC
- 6 configurable I/Os
- Supports numerous IP network standards



Technical specifications for AIP38906-02 / AIP38907-02 / AIP38904-02

Weight	300 g
Dimensions (W x H x D)	105 x 105 x 46 mm 105 x 173 x 63 mm (AIP38904-02)
Operating voltage	PoE, PoE+: IEEE 802.3af, IEEE 802.3at or ext. power supply: 16-48VDC
Current/Power	Idle mode approx. 1,8 watts Voice transmission max. 12 watts
Temperature	-40 °C to + 70°C
Protection class	IP54
Material	V4A front panel, Aluminum frame
Ports	Ethernet: 2 x RJ45 I/O: 6x configurable Relay output: Max. 250 VAC/220 VDC, 2A, 60 W Outputs: 12mA for LED control Audio output: Line level / 600 Ohm
Built-in amplifier	Digital, 10 watt output power
Microphone	Electret microphone
DTMF	RFC 2833 (Outband), RFC2976 (SIP-Info)
Protocols	IPv4 (with DiffServ), SIP, TCP, UDP, HTTPS, TFTP, RTP, RTSP, RTCP, SRTP, DHCP, SNMP, Vingtor-Stentofon CCoIP®, NTP, ONVIF, WS-Discovery
Audiocodex	G.711, G.722, G.729
Management & Operation	HTTP/HTTPS (web configuration) DHCP and static IP address assignment, remote software upgrade, central monitoring

3096613024

AIP38907-02 Voice module TKIE3-ST

- SMIP2 voice module with VA4 front panel for use with keypad module
- Features TKIE-3CC with 2 relay outputs, 2 network ports and a port for keypad module
- Technical specifications see above with AIP38906-02

3096613017
**AIP38904-02 Audio module
TKIE1-NT**

- SMIP2 audio module with VA4 front panel for use with 3096613014 SMIP2 emergency call module without glass or 3096613015 SMIP2 emergency call module with glass
- Contains the loudspeaker unit with microphone and call status display as well as a "loose" TKIE1 module.
- The product is only available in combination with the order of a complete intercom station and corresponding module installation, in which one of the two emergency call modules mentioned above is installed.
- For technical features see above AIP38906-02

3096613003
**AIP38961-06 Camera module
DOME-A1**

- SMIP2 camera module DOME with VA4 front panel
- For indoor use
- Frame rate up to 30 fps
- Resolution 1920 x 1080p
- IR illumination: 10 m max. distance with 0 lux wide-angle lens
- Viewing angle: horizontal=108°, vertical=61°
- ONVIF profiles S & T compliant
- MJPEG, H.264, H.265



Technical specifications	
Weight	250 g
Dimensions (W x H x D)	105 x 105 x 71,5 mm
Power supply	6 Watt, PoE IEEE 802.3af Class 2
Temperature	-10°C to - 50°C
Protection class	For indoor use
Material	V4A front panel, Aluminum frame
Sensor	1/2.8 Progressive Scan CMOS
Resolution (Pixel)	1920 x 1080 p
FPS	30 bei 1920 x 1080 p
Lens	F2.0, fixed aperture
Parallel video streams	2 independent resolutions, multistream
Aperture angle	horizontal=108°, vertical= 61°
Compression	MJPEG, H.264, H.265
Light sensitivity	With IR: 0 Lux; without IR: 0,005-0,01 Lux
ONVIF	Profile S + T + G

3096613022
**AIP38965-06 Camera module
DOME-A2**

- SMIP2 camera module with VA4 front panel and dome made of impact-resistant optical glass; plastic dome frame
- 5MP sensor for higher resolution
- Lens in camera can be mechanically adjusted > optimum setting of the detection range
- Power supply / operation via 48V PoE port separate from the intercom system
- Frame rate up to 30 fps
- Resolution up to 2592 x 1944
- Viewing angle: horizontal=108°, vertical= 61°
- ONVIF profiles S & T compliant
- Compression MJPEG, H.264, H.265



Technical specifications	
Weight	350 g
Dimensions (W x H x D)	105 x 105 x 77,5 mm
Power supply	6 Watt, PoE IEEE 802.3af Class 2
Temperature	-10°C to - 50°C
Protection class	IP54
Material	V4A front panel, Aluminum frame
Sensor	1/2.8 Progressive Scan CMOS
Resolution (Pixel)	2592 x 1944 p / 2048 x 1536 p 2560 x 1440 p 1920 x 1080 p
FPS	30 bei 1920 x 1080 p und 60 Hz
Lens	F2.0, fixed aperture
Parallel video streams	2 independent resolutions, multistream
Aperture angle	horizontal=100°, vertical= 54°
Compression	MJPEG, H.264, H.265
Light sensitivity	With IR: 0 Lux; without IR: 0,005-0,01 Lux
ONVIF	Profile S + T + G

Call Modules

3096613006

AIP38941-04 Call-button module 1

- SMIP2 push-button module with V4A front panel
- 1-4 stainless steel call buttons
- Large text field (52x77mm) with LED backlighting to accommodate an individual nameplate via rear insertion
- Cascadable up to 4 modules and up to 15 buttons



A pre-assembled connection cable must be ordered separately for each module:

SMIP2 Cable set buttons TKI

Connects the call-button module to a TKIS, TKIE or TKIV+ voice module

- 3096612001 (150 mm) Standard length
- 3096612004 (250 mm) Special length for horizontal module frame when the call-button module is next to the voice module

SMIP2 Cable set buttons-buttons

Required to connect additional call-button modules > cascading from the first to the second module

- 3096612002 Standard length
- 3096612003 (1000 mm) Special length with round cable for an additional remote call-button module



3096613007
AIP38942-04 Call-button
module 2



3096613008
AIP38943-04 Call-button
module 3



3096613009
AIP38944-04 Call-button
module 4

3096613011

AIP38948-04 Central call-button module

- SMIP2 central call-button module with vandal-proof stainless steel call-button with bell symbol
- LED lighting (white)
- Power supply via voice module (connection: plug-in screw terminals)
- For connection to voice module instead of or in addition to the call-button module



Different versions

Scroll module

- SMIP2 scroll module with V4A front panel and OLED matrix display
- 4 buttons for operation: scrolling through call destinations, call setup, call end
- 3096613004 SMIP2 Scroll module TKIV+: for use with voice module-TKIV+
- 3096613028 SMIP2 Scroll Module-TKIS: for use with Voice module TKIS1 or Voice module TKIS2 or TKIE



3096613016

AIP38947-04 Keypad module

- SMIP2 keypad module with V4A front panel
- Free entry of phone numbers
- For use with the voice module TKIE3-ST (AIP38907-02)
- Selection of stored speed dialling destinations



3096613014

AIP38963-06 Emergency call module without glass

- SMIP2 emergency call module with V4A front panel
- Yellow field with bell symbol button – without glass

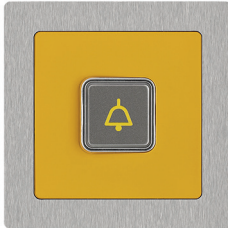

3096613015

AIP38964-06 Emergency call module with safety glass

- SMIP2 emergency call module with V4A front panel
- Yellow field with bell symbol button – with safety glass

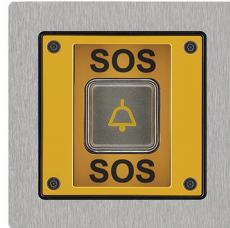

3096613018

AIP38913-10 Key switch module

- SMIP2 key switch module
- Universal key switch with 2 switching pos.
- Profile cylinder B5LT (Abus), 10/30 mm, 3 keys
- 2 micro switches (push-button contacts) with 3-pin cable connection (NO, NC, Common)
- 3 LED indicators (DUO-LED) red + green
- 6-pin connection cable for the LEDs



Other modules

3096613019

AIP38914-10 Light panel module

- SMIP2 light panel module for visual display of operating states
- 4 white illuminated LED light fields
- Pictograms, text, color interchangeable via inlay foil
- Power supply DC 5V / 20mA per active light field



3096613005

AIP38912-10 Blank module

- SMIP2 blank module made of V4A for covering extension spaces
- with welding studs and nuts



3096613010

AIP38962-06 Universal module without mounting

- SMIP2 universal module for individual assembly by the customer
- Stainless steel front panel with opening for the installation of components from various manufacturers

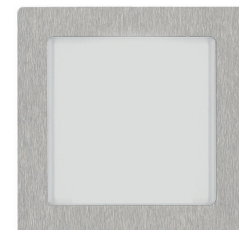

3096613013

AIP38967-06 Universal transponder module

- SMIP2 universal transponder module
- V4A front plate with acrylic glass insert
- For mechanical integration of customer-specific readers (mounting kit)
- Reader and corresponding cabling are provided by the customer
- 8 M3 threads with a 46 x 46 mm and 32 x 32 mm pitch are available on the rear for mounting the reader. See dimensional drawing.
- The lettering (RFID symbol, Scanvest lettering) is realized via a lettering insert (foil), which can be replaced by the customer.



Options & special modules

3096613050

AIP38911-05 External reader module Ekey

- SMIP2 third-party reader module with V4A front panel and plastic inlay
- For mounting a fingerprint reader Ekey home FS UP1 (angled installation) – reader to be provided by the customer
- Areas of application: Access control, time recording, store floor data collection, parking systems, alarm systems, general user identification



3096613051

AIP38912-05 Third-party reader module PHG standard

- SMIP2 third-party reader module with V4A front plate
- Mounting kit for the use of PHG readers
- Areas of application: Access control, time recording, operational data logging, parking systems, alarm systems, general user identification
- Suitable for the following PHG readers: LEGIC prime, LEGIC advant, MIFARE Classic, MIFARE DESFire EV1/EV2, 125 kHz, ISO14443A (CSN / UID), ISO15693 (CSN / UID), Sony FeliCa (CSN / UID), Inside Secure (CSN / UID)



3096613052

AIP38913-05 Third-party reader module PHG keyboard

- SMIP2 third-party reader module with V4A front plate
- Mounting kit for the use of PHG readers with keypad
- Areas of application: Access control, time recording, operational data logging, parking systems, alarm systems, general user identification
- Suitable for the following PHG readers: LEGIC prime, LEGIC advant, MIFARE Classic, MIFARE DESFire EV1/EV2, 125 kHz, ISO14443A (CSN / UID), ISO15693 (CSN / UID), Sony FeliCa (CSN / UID), Inside Secure (CSN / UID)

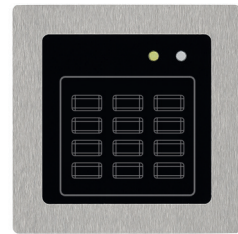

3096613054

AIP38915-05 Third-party reader module Telenot

- SMIP2 third-party reader module with V4A front plate and plastic insert
- For mounting a transponder reader from Telenot, reader type: BLM10 D uP, article number Telenot: 100077630
- Areas of application: Access control, time recording, store floor data collection, parking systems, alarm systems, general user identification



3096613025

AIP38968-06 RD6 transponder switch

- SMIP2 transponder switch module with V4A front plate
- Can be used both independently and via bus for access control
- Power supply 24V DC



Compatible Station kits

2111110076

TKIS-2 VoIP Intercom Module

- For creating your own intercom units or VoIP loudspeaker systems
- **Can also be used as a SIP relay module**
- High-end audio quality: automatic volume adjustment, active noise cancelling, open duplex, etc.
- Digital amplifier with 10 watt output power
- Programmable control relay
- 6 freely configurable I/O ports
- 0 dB output for connecting external amplifiers
- Integrated web server for easy configuration and monitoring
- All current network security standards and adaptive firewall
- PoE supply
- A TKIA-2 gateway is available to extend the analog interface of the TKIS-2 up to 60 m



Dimensions (WxHxD): 117 x 71 x 32 mm

2110210174

IP-LCM-A Remote I/O unit

- Extension to the TKIS-2 VoIP Intercom module, adding high performance relays and robust control inputs to the kit without additional cabling
- 8 relay outputs
- 8 control inputs
- Robust connectors for cables up to 1.5 mm² / 16 AWG
- Power supply via the TKIS-2 module (PoE or local power supply)
- All TKIS-2 functions additionally available
- 1 additional relay
- 6 additional control inputs

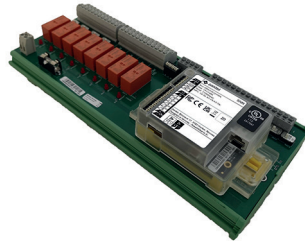

Dimensions (WxHxD): 270.5 x 125.4 x 66.6 mm

Ideal for answering calls

2111110119

ITSV-4 HD IP Desktop Terminal with touch display

- 4-core 1.8 GHz ARM Cortex A55 processor with 2 GB RAM and 16 GB eMMC Flash
- Runs on the Android 11 operating system
- 5.0" (1280x720) capacitive 5-point touchscreen HD TFT LCD
- Integrated Bluetooth 5.0
- Integrated dual-band WLAN 5 (2.4 GHz 5 GHz)
- Built-in PoE/PoE+
- Built-in tiltable 2-megapixel CMOS camera with privacy shutter, 720p 30fps
- 10-way audio conferencing and 3-way video conferencing function
- HD speakerphone Dual-switched 10/100/1000 Mbps network ports with automatic detection
- Supports up to 16 SIP accounts



Dimensions (WxHxD): 196.5 x 206 x 85 mm

Many other intercom stations from our portfolio are suitable for answering calls. Feel free to contact us for alternatives!

Module frame XS

Different versions

Module frame XS

- Aluminum module frame for SMIP2
- Various sizes
- For mounting from the front directly on the wall, on flush-mounted or surface-mounted box and in columns
- Silver or black anodized

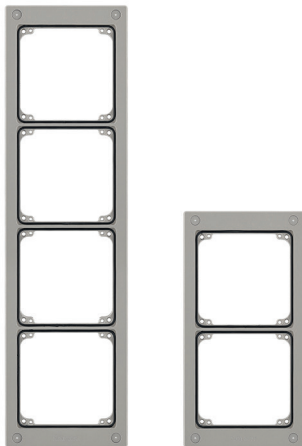

3096614121

AIP38911-07 Module frame XS 1x1
Dimensions: 130 x 146 x 8 mm

3096614122

AIP38912-07 Module frame XS 1x2
Dimensions: 130 x 254 x 8 mm

3096614123

AIP38913-07 Module frame XS 1x3
Dimensions: 130 x 362 x 8 mm

3096614124

AIP38914-07 Module frame XS 1x4
Dimensions: 130 x 470 x 8 mm

3096614125

AIP38915-07 Module frame XS 1x5
Dimensions: 130 x 578 x 8 mm

3096614126

AIP38922-07 Module frame XS 2x2
Dimensions: 238 x 254 x 8 mm

3096614127

AIP38923-07 Module frame XS 2x3
Dimensions: 238 x 362 x 8 mm

3096614128

AIP38924-07 Module frame XS 2x4
Dimensions: 238 x 470 x 8 mm

Module frame XL

Different versions

Module frame XL

- Modular aluminum frame for the migration of SMIP1 intercom stations
- Various sizes
- For mounting from the front directly on the wall, on flush-mounted or surface-mounted box and in pedestals
- Silver

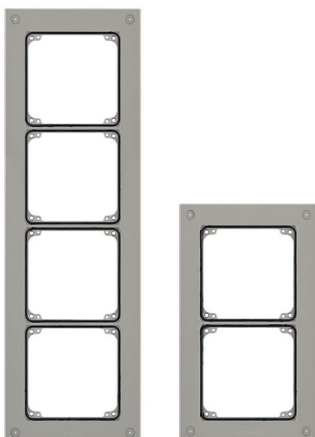

3096614101

AIP38941-07 Module frame XL 1x1
Dimensions: 150 x 150 x 8 mm

3096614102

AIP38942-07 Module frame XL 1x2
Dimensions: 150 x 260 x 8 mm

3096614103

AIP38943-07 Module frame XL 1x3
Dimensions: 150 x 370 x 8 mm

3096614104

AIP38944-07 Module frame XL 1x4
Dimensions: 150 x 480 x 8 mm

3096614105

AIP38945-07 Module frame XL 1x5
Dimensions: 150 x 590 x 8 mm

3096614106

AIP38952-07 Module frame XL 2x2
Dimensions: 260 x 260 x 8 mm

3096614107

AIP38953-07 Module frame XL 2x3
Dimensions: 260 x 370 x 8 mm

3096614108

AIP38954-07 Module frame XL 2x4
Dimensions: 260 x 480 x 8 mm

Important note for existing customers: Module frames XL are the right frames if you want to replace your existing ScanModule SMIP1 intercom stations (built until 2022) with SMIP2. This means you can continue to use your existing housings.

Module rear frame

Different versions

Module rear frame

- Modular frame rear structure made of aluminum for columns and mailbox systems
- Various sizes
- Black

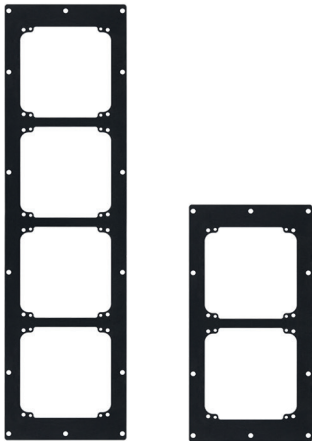

3096614141

AIP38931-07 Module frame HB 1x1
Dimensions: 132 x 146 x 6 mm

3096614142

AIP38932-07 Module frame HB 1x2
Dimensions: 132 x 254 x 6 mm

3096614143

AIP38933-07 Module frame HB 1x3
Dimensions: 132 x 362 x 6 mm

3096614144

AIP38934-07 Module frame HB 1x4
Dimensions: 132 x 470 x 6 mm

3096614145

AIP38935-07 Module frame HB 1x5
Dimensions: 132 x 578 x 6 mm

3096614152

AIP38972-07 Module frame HB 1x2 Quer
Dimensions: 254 x 132 x 6 mm

3096614153

AIP38973-07 Module frame HB 1x3 Quer
Dimensions: 362 x 132 x 6 mm

3096614154

AIP38974-07 Module frame HB 1x4 Quer
Dimensions: 470 x 132 x 6 mm

3096614155

AIP38975-07 Module frame HB 1x5 Quer
Dimensions: 578 x 132 x 6 mm



Flush or cavity wall mounting

Different versions

Flush-mounted housing

- Flush-mounted housing for SMIP2

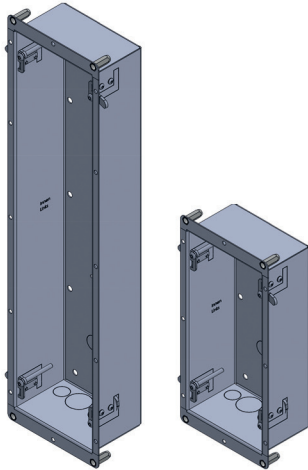

3096618151

AIP38911-08 Flush-mounted housing XL 1x1
Dimensions: 119 x 135 x 65 mm

3096618152

AIP38912-08 Flush-mounted housing XL 1x2
Dimensions: 119 x 243 x 65 mm

3096618153

AIP38913-08 Flush-mounted housing XL 1x3
Dimensions: 119 x 351 x 65 mm

3096618154

AIP38914-08 Flush-mounted housing XL 1x4
Dimensions: 119 x 459 x 65 mm

3096618155

AIP38915-08 Flush-mounted housing XL 1x5
Dimensions: 119 x 567 x 65 mm

3096618156

AIP38922-08 Flush-mounted housing XL 2x2
Dimensions: 227 x 243 x 65 mm

3096618157

AIP38923-08 Flush-mounted housing XL 2x3
Dimensions: 227 x 351 x 65 mm

3096618158

AIP38924-08 Flush-mounted housing XL 2x4
Dimensions: 227 x 459 x 65 mm

3096618146

AIP38941-08 Cavity wall mounting kit SMIP2

2926210047

AIP38939 Cavity wall mounting kit SMIP

Surface mounting

Different versions

Surface-mounted housing

- Surface-mounted housing for SMIP2

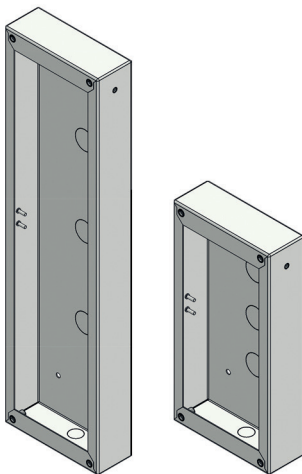

3096618131

AIP38911-09 Surface-mounted housing 1x1
Dimensions: 128 x 144 x 47 mm

3096618132

AIP38912-09 Surface-mounted housing 1x2
Dimensions: 128 x 252 x 47 mm

3096618133

AIP38913-09 Surface-mounted housing 1x3
Dimensions: 128 x 360 x 47 mm

3096618134

AIP38914-09 Surface-mounted housing 1x4
Dimensions: 128 x 468 x 47 mm

3096618135

AIP38915-09 Surface-mounted housing 1x5
Dimensions: 128 x 576 x 47 mm

3096618136

AIP38922-09 Surface-mounted housing 2x2
Dimensions: 236 x 252 x 47 mm

3096618137

AIP38923-09 Surface-mounted housing 2x3
Dimensions: 236 x 360 x 47 mm

3096618138

AIP38924-09 Surface-mounted housing 2x4
Dimensions: 236 x 468 x 47 mm

3096618140

AIP38915-09 Weather protection roof 130
Abmessungen: 130 x 135 x 70 mm

3096618141

AIP38916-10 Weather protection roof 238
Abmessungen: 130 x 238 x 70 mm

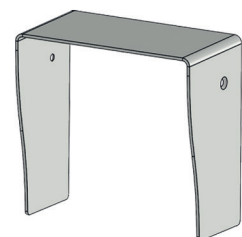

Frames & boxes for GS series

Different versions

Module frame GS

- Stainless steel module frame for migration to GS series housings
- Various sizes
- For mounting from the front directly on the wall, on flush-mounted or surface-mounted box and in pedestals
- Silver
- Fastening with latches

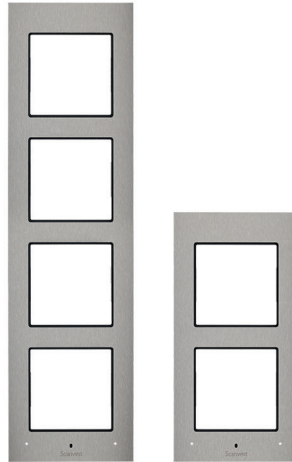

2921710051

AIP38961-07 Module frame GS 1x1
Dimensions: 155 x 180 mm

2921710052

AIP38962-07 Module frame GS 1x2
Dimensions: 155 x 310 mm

2921710053

AIP38963-07 Module frame GS 1x3
Dimensions: 155 x 440 mm

2921710054

AIP38964-07 Module frame GS 1x4
Dimensions: 155 x 570 mm

2921710055

AIP38965-07 Module frame GS 1x5
Dimensions: 155 x 700 mm

Important note for existing customers: GS module frames are the right frames if you want to replace your existing GS intercom stations (analog or IP) with SMIP2. This means you can continue to use your existing housings.

Different versions

Flush-mounted housing GS

- Flush-mounted housing for GS design for use with SMIP2 GS module frame

10651831

AIP38811-08 Flush-mounted housing GS 1x1
Dimensions: 158 x 135 x 80 mm

10651832

AIP38812-08 Flush-mounted housing GS 1x2
Dimensions: 290 x 135 x 80 mm

10651833

AIP38813-08 Flush-mounted housing GS 1x3
Dimensions: 417 x 135 x 80 mm

10651834

AIP38814-08 Flush-mounted housing GS 1x4
Dimensions: 550 x 135 x 80 mm

Different versions

Cavity wall housing GS

- Cavity wall housing for GS design for use with SMIP2 GS module frame

10651805

AIP38821-08 Cavity wall housing GS 1x1
Dimensions: 158 x 135 x 75 mm

10651806

AIP38822-08 Cavity wall housing GS 1x2
Dimensions: 290 x 135 x 75 mm

10651807

AIP38823-08 Cavity wall housing 1x3
Dimensions: 417 x 135 x 75 mm

10651808

AIP38824-08 Cavity wall housing 1x4
Dimensions: 550 x 135 x 75 mm

Different versions

Surface-mounted housing GS

- Surface-mounted housing for GS design for use with SMIP2 GS module frame

10651809

AIP38811-09 Surface-mounted housing GS 1x1
Dimensions: 182 x 175 x 50 mm

10651810

AIP38812-09 Surface-mounted housing GS 1x2
Dimensions: 312 x 175 x 50 mm

10651811

AIP38813-09 Surface-mounted housing GS 1x3
Dimensions: 442 x 175 x 50 mm

10651812

AIP38814-09 Surface-mounted housing GS 1x4
Dimensions: 572 x 175 x 50 mm

Overview ScanModul Articles

Article No.	Name	AIP No.	Module type	Description
Voice & Video modules				
3096613001	SMIP2 Audio module TKIV+ as kit	AIP38901-02	Audio module	TKIV+ audio module with call status display, price only valid in combination with TKIV+ camera module
3096613002	SMIP2 Video mod. TKIV+	AIP38931-03	Video module	TKIV+ video module for use in combination with the TKIV+ voice module
3096613026	SMIP2 Audio module TKIS1	AIP38908-02	Audio module	TKIS1 audio module with call status display, 1 network connection, 1 relay output, without switch – ideal for separately supplied cameras
3096613027	SMIP2 Audio module TKIS2	AIP38905-02	Audio module	TKIS2 audio module with call status display, 1 network connection, 2 relay outputs, switch for connecting and supplying camera modules
3096613020	SMIP2 Video module TKIS	AIP38932-03	Video module	Video module without dome, own IP address, IR night vision function, for connection to the TKIS voice module
3096613003	SMIP2 Video module DOME-A1	AIP38961-06	Video module	Video module with dome, including an H6 Mini Dome camera from Avigilon, 2MP resolution, mechanically adjustable viewing angle
3096613022	SMIP2 Video module DOME-A2	AIP38965-06	Video module	Video module with dome made of optical glass, including an H6 Mini Dome camera from Avigilon, 5MP resolution, mechanically adjustable viewing angle
3096613023	SMIP2 Audio module TKIE1-ST	AIP38906-02	Audio module	Audio module for standard call-buttons with call status display, only for use with call-button modules 1-4 or scroll module, contains a TKIE-1, 2 relay outputs, 2 network ports
3096613024	SMIP2 Audio module TKIE3-ST	AIP38907-02	Audio module	Audio module for standard buttons with call status display, only for use with keypad module, contains a TKIE-3CC, 2 relay outputs, 2 network connections
3096613017	SMIP2 Audio module TKIE1-NT	AIP38904-02	Audio module	Audio module for use with 3096613014 SMIP2 Emergency call module without glass and 3096613015 SMIP2 Emergency call module with glass
Call modules				
3096613011	SMIP2 Central call-button module	AIP38948-04	Call module	Call-button module with a white illuminated button with bell symbol and connection cables to the voice module
3096613006	SMIP2 Call-button module 1	AIP38941-04	Call module	Call-button module with one button, large illuminated text field (52x77mm), cascadable up to 4 modules & up to 15 buttons. Order connection cable separately!
3096613007	SMIP2 Call-button module 2	AIP38942-04	Call module	Call-button module with 2 buttons, large illuminated text field (52x77mm), cascadable up to 4 modules & up to 15 buttons. Order connection cable separately!
3096613008	SMIP2 Call-button module 3	AIP38943-04	Call module	Call-button module with 3 buttons, large illuminated text field (52x77mm), cascadable up to 4 modules & up to 15 buttons. Order connection cable separately!
3096613009	SMIP2 Call-button module 4	AIP38944-04	Call module	Call-button module with 4 buttons, large illuminated text field (52x77mm), cascadable up to 4 modules & up to 15 buttons. Order connection cable separately!
3096612001	SMIP2 Cable set - buttons - TKI-150 mm	AIP38910-10	Accessory	Cable set 150 mm, 6-pin with JST socket plug for call-button modules 1-4 and open end, pre-tinned for connection to the voice module
3096612004	SMIP2 Cable set - buttons - TKI - 250mm	AIP38918-10	Accessory	Cable set 250 mm, 6-pin with JST socket plug for call-button modules 1-4 and open end, pre-tinned for connection to the voice module
3096612002	SMIP2 Cable set - buttons-buttons	AIP38911-10	Accessory	Cable set 80 mm, 6-pin on both sides with JST socket plug for cascading additional button modules
3096612003	SMIP2 Cable set - buttons-buttons - 1m	AIP38917-10	Accessory	Cable set, 6-pin on both sides with JST socket plug for cascading additional call-button modules. Length 1m to operate one call-button module remotely
3096613004	SMIP2 Scroll module TKIV+	AIP38949-04	Call module	Operating module with OLED display, 2 scroll buttons and 2 function buttons
3096613028	SMIP2 Scroll module TKIS	AIP38950-04	Call module	Operating module with OLED display, 2 scroll buttons and 2 function buttons For use with audio module-TKIS1 or voice module-TKIS2
3096613014	SMIP2 Emergency call module without glass	AIP38963-06	Special module	Operating module for emergency call, call button with LED lighting and self-test function, inlay with yellow powder coating
3096613015	SMIP2 Emergency call module with glass	AIP38964-06	Special module	Operating module for emergency call, call button with LED lighting and self-test function behind a glass panel, inlay with yellow powder coating
3096613016	SMIP2 Keypad module	AIP38947-04	Call module	Operating module with 12-key keypad and 3x4 matrix output for speed dialling numbers or entering access codes; requires a TKIE-3 with matrix interface
3096613018	SMIP2 Key switch module	AIP38913-10	Accessory	Operating module with switching contact, for installation of a standard locking cylinder design 30/10 mm
Other modules				
3096613019	SMIP2 Light panel mod.	AIP38914-10	Accessory	Display module with front panel, 4 illuminated fields and inlay foil with symbols
3096613005	SMIP2 Blank module	AIP38912-10	Accessory	Blank module with screw set to cover an unused module space
3096613013	SMIP2 Universal transponder module	AIP38905-02	Reader module	Module with front panel and acrylic glass insert, universal mounting of a transponder reader on the back (not included)
3096613010	SMIP2 Universal module without mounting	AIP38962-06	Special module	Front panel with 77.5 x 77.5 mm opening for the installation of project-specific components using an installation kit, available on request
3096613025	SMIP2 RD6 transponder switch	AIP38968-06	Special module	Transponder reader that can be used both independently and via bus for access control. Power supply 24V DC

Article No.	Name	AIP No.	Module type	Description
Options & Special modules				
3096613050	SMIP2 External reader module-Ekey>Home FS-UP1 angled instal.	AIP38911-05	Accessory	Module with plastic insert, to accommodate an Ekey home FS UP1 fingerprint reader (inclined installation) at the rear, which must be provided
3096613051	SMIP2 Third-party reader module PHG standard	AIP38912-05	Accessory	Module with plastic insert for mounting PHG transponder readers without keypad. Note: Installation possible at PHG
3096613052	SMIP2 Third-party reader module PHG keyboard	AIP38913-05	Accessory	Module with plastic insert for mounting PHG transponder reader with keypad: Note: Mounting & gluing of membrane keypad must be carried out at PHG
3096613053	SMIP2 Installation kit for remote reader in keypad	AIP38914-05	Accessory	Mounting kit for installing a third-party reader system with remote coil in the call-button module behind the labeling field
3096613054	SMIP2 Fremdleser-modul-Telenot	AIP38915-05	Accessory	Third-party reader module-Telenot with stainless steel front plate and plastic insert for mounting a transponder reader from Telenot, type BLM10 D uP, article number Telenot: 100077630
Kompatible station kits				
2111110076	TKIS-2 VoIP-Intercom-Module	TKIS-2	Accessory	VoIP intercom module for creating your own intercom stations or VoIP loudspeaker systems
2110210174	IP-LCM-A Remote I/O unit	IP-LCM-A	Accessory	Extension to the TKIS-2 intercom kit, which adds high-performance relays and robust control inputs to the kit without additional cabling
Ideal for answering calls				
2111110119	TSV-4 HD-IP-Desktop Terminal	ITSV-4	Accessory	IP desktop terminal with touch display for answering calls
Module frames XS				
3096614121	SMIP2 SMIP2 Module frame-XS-1x1	AIP38911-07	Module frame	Module frame: 1x1 module, mounting of SMIP2 on flush-mounted and surface-mounted housing, incl. M5 screw set + screw connection cover caps
3096614122	SMIP2 SMIP2 Module frame-XS-1x2	AIP38912-07	Module frame	Module frame: 1x2 module, mounting of SMIP2 on flush-mounted and surface-mounted housing, incl. M5 screw set + screw connection cover caps
3096614123	SMIP2 SMIP2 Module frame-XS-1x3	AIP38913-07	Module frame	Module frame: 1x3 module, mounting of SMIP2 on flush-mounted and surface-mounted housing, incl. M5 screw set + screw connection cover caps
3096614124	SMIP2 SMIP2 Module frame-XS-1x4	AIP38914-07	Module frame	Module frame: 1x4 module, mounting of SMIP2 on flush-mounted and surface-mounted housing, incl. M5 screw set + screw connection cover caps
3096614125	SMIP2 SMIP2 Module frame-XS-1x5	AIP38915-07	Module frame	Module frame: 1x5 module, mounting of SMIP2 on flush-mounted and surface-mounted housing, incl. M5 screw set + screw connection cover caps
3096614126	SMIP2 SMIP2 Module frame-XS-2x2	AIP38922-07	Module frame	Module frame: 2x2 module, mounting of SMIP2 on flush-mounted and surface-mounted housing, incl. M5 screw set + screw connection cover caps
3096614127	SMIP2 SMIP2 Module frame-XS-2x3	AIP38923-07	Module frame	Module frame: 2x3 module, mounting of SMIP2 on flush-mounted and surface-mounted housing, incl. M5 screw set + screw connection cover caps
3096614128	SMIP2 SMIP2 Module frame-XS-2x4	AIP38924-07	Module frame	Module frame: 2x4 module, mounting of SMIP2 on flush-mounted and surface-mounted housing, incl. M5 screw set + screw connection cover caps
Modulrahmen XL				
3096614101	SMIP2 Module frame-XL-1x1	AIP38941-07	Module frame	Module frame: 1x1 module, mounting of SMIP2 on SMIP1 generation surface-mounted/flush-mounted housing, incl. M5 screw set + screw connection cover caps
3096614102	SMIP2 Module frame-XL-1x2	AIP38942-07	Module frame	Module frame: 1x2 module, mounting of SMIP2 on SMIP1 generation surface-mounted/flush-mounted housing, incl. M5 screw set + screw connection cover caps
3096614103	SMIP2 Module frame-XL-1x3	AIP38943-07	Module frame	Module frame: 1x3 module, mounting of SMIP2 on SMIP1 generation surface-mounted/flush-mounted housing, incl. M5 screw set + screw connection cover caps
3096614104	SMIP2 Module frame-XL-1x4	AIP38944-07	Module frame	Module frame: 1x4 module, mounting of SMIP2 on SMIP1 generation surface-mounted/flush-mounted housing, incl. M5 screw set + screw connection cover caps
3096614105	SMIP2 Module frame-XL-1x5	AIP38945-07	Module frame	Module frame: 1x5 module, mounting of SMIP2 on SMIP1 generation surface-mounted/flush-mounted housing, incl. M5 screw set + screw connection cover caps
3096614106	SMIP2 Module frame-XL-2x2	AIP38952-07	Module frame	Module frame: 2x2 module, mounting of SMIP2 on SMIP1 generation surface-mounted/flush-mounted housing, incl. M5 screw set + screw connection cover caps
3096614107	SMIP2 Module frame-XL-2x3	AIP38953-07	Module frame	Module frame: 2x3 module, mounting of SMIP2 on SMIP1 generation surface-mounted/flush-mounted housing, incl. M5 screw set + screw connection cover caps
3096614108	SMIP2 Module frame-XL-2x4	AIP38954-07	Module frame	Module frame: 2x4 module, mounting of SMIP2 on SMIP1 generation surface-mounted/flush-mounted housing, incl. M5 screw set + screw connection cover caps

Important note for existing customers: Module frames XL are the right frames if you want to replace your existing ScanModule SMIP1 intercom stations (built until 2022) with SMIP2. This means you can continue to use your existing housings.

Article No.	Name	AIP No.	Module type	Description
Vertical rear structure – pedestals & letterboxes				
3096614141	SMIP2 Module frame-HB-1x1	AIP38931-07	Module frame	Vertical module frame: 1x1 module, rear mounting in pedestals/mailboxes, attachment to welding studs to be provided there
3096614142	SMIP2 Module frame-HB-1x2	AIP38932-07	Module frame	Vertical module frame: 1x2 module, rear mounting in pedestals/mailboxes, attachment to welding studs to be provided there
3096614143	SMIP2 Module frame-HB-1x3	AIP38933-07	Module frame	Vertical module frame: 1x3 module, rear mounting in pedestals/mailboxes, attachment to welding studs to be provided there
3096614144	SMIP2 Module frame-HB-1x4	AIP38934-07	Module frame	Vertical module frame: 1x4 module, rear mounting in pedestals/mailboxes, attachment to welding studs to be provided there
3096614145	SMIP2 Module frame-HB-1x5	AIP38935-07	Module frame	Vertical module frame: 1x5 module, rear mounting in pedestals/mailboxes, attachment to welding studs to be provided there
Horizontal rear structure – pedestals & letterboxes				
3096614152	SMIP2 Module frame-HB-1x2-horizontal	AIP38972-07	Module frame	Module frame horizontal: 1x2 modules for rear mounting in pedestals/mailboxes, attachment to welding studs to be provided there
3096614153	SMIP2 Module frame-HB-1x3-horizontal	AIP38973-07	Module frame	Module frame horizontal: 1x3 modules for rear mounting in pedestals/mailboxes, attachment to welding studs to be provided there
3096614154	SMIP2 Module frame-HB-1x4-horizontal	AIP38974-07	Module frame	Module frame horizontal: 1x4 modules for rear mounting in pedestals/mailboxes, attachment to welding studs to be provided there
3096614155	SMIP2 Module frame-HB-1x5-horizontal	AIP38975-07	Module frame	Module frame horizontal: 1x5modules for rear mounting in pedestals/mailboxes, attachment to welding studs to be provided there
Flush-mounted housing + mounting kits				
3096618151	SMIP2 Flush-mounted housing-1x1	AIP38911-08	Flush-mounted housing	Deep flush-mounted housing: 1x1 modules, installation in wall cut-outs/dry walls in conjunction with cavity wall mounting kit
3096618152	SMIP2 Flush-mounted housing-1x2	AIP38912-08	Flush-mounted housing	Deep flush-mounted housing: 1x2 modules, installation in wall cut-outs/dry walls in conjunction with cavity wall mounting kit
3096618153	SMIP2 Flush-mounted housing-1x3	AIP38913-08	Flush-mounted housing	Deep flush-mounted housing: 1x3 modules, installation in wall cut-outs/dry walls in conjunction with cavity wall mounting kit
3096618154	SMIP2 Flush-mounted housing-1x4	AIP38914-08	Flush-mounted housing	Deep flush-mounted housing: 1x4 modules, installation in wall cut-outs/dry walls in conjunction with cavity wall mounting kit
3096618155	SMIP2 Flush-mounted housing-1x5	AIP38915-08	Flush-mounted housing	Deep flush-mounted housing: 1x5 modules, installation in wall cut-outs/dry walls in conjunction with cavity wall mounting kit
3096618156	SMIP2 Flush-mounted housing-2x2	AIP38922-08	Flush-mounted housing	Deep flush-mounted housing: 2x2 modules, installation in wall cut-outs/dry walls in conjunction with cavity wall mounting kit
3096618157	SMIP2 Flush-mounted housing-2x3	AIP38923-08	Flush-mounted housing	Deep flush-mounted housing: 2x3 modules, installation in wall cut-outs/dry walls in conjunction with cavity wall mounting kit
3096618158	SMIP2 Unterputzgehäuse-2x4	AIP38924-08	Flush-mounted housing	Deep flush-mounted housing: 2x4 modules, installation in wall cut-outs/dry walls in conjunction with cavity wall mounting kit
3096618146	Cavity wall mounting kit SMIP2	AIP38941-08	Accessory	Mounting kit for SMIP2 flush-mounted housing, 4-fold, in conjunction with module frame X5
2926210047	Cavity wall mounting kit SMIP1	AIP38939	Accessory	Mounting kit for SMIP1 flush-mounted housing in conjunction with module frame XL
Surface-mounted housing + weather protection roofs				
3096618131	SMIP2 Surface-mounted housing-1x1	AIP38911-09	Surface-mount. housing	Surface-mounted housing 1x1 modules, installation height 47 mm for SMIP2 with screws, plugs; sealing strips applied to the rear for wall support
3096618132	SMIP2 Surface-mounted housing-1x2	AIP38912-09	Surface-mount. housing	Surface-mounted housing 1x2 modules, installation height 47 mm for SMIP2 with screws, plugs; sealing strips applied to the rear for wall support
3096618133	SMIP2 Surface-mounted housing-1x3	AIP38913-09	Surface-mount. housing	Surface-mounted housing 1x3 modules, installation height 47 mm for SMIP2 with screws, plugs; sealing strips applied to the rear for wall support
3096618134	SMIP2 Surface-mounted housing-1x4	AIP38914-09	Surface-mount. housing	Surface-mounted housing 1x4 modules, installation height 47 mm for SMIP2 with screws, plugs; sealing strips applied to the rear for wall support
3096618135	SMIP2 Surface-mounted housing-1x5	AIP38915-09	Surface-mount. housing	Surface-mounted housing 1x5 modules, installation height 47 mm for SMIP2 with screws, plugs; sealing strips applied to the rear for wall support
3096618136	SMIP2 Surface-mounted housing-2x2	AIP38922-09	Surface-mount. housing	Surface-mounted housing 2x2 modules, installation height 47 mm for SMIP2 with screws, plugs; sealing strips applied to the rear for wall support
3096618137	SMIP2 Surface-mounted housing-2x3	AIP38923-09	Surface-mount. housing	Surface-mounted housing 2x3modules, installation height 47 mm for SMIP2 with screws, plugs; sealing strips applied to the rear for wall support
3096618138	SMIP2 Surface-mounted housing-2x4	AIP38924-09	Surface-mount. housing	Surface-mounted housing 2x4 modules, installation height 47 mm for SMIP2 with screws, plugs; sealing strips applied to the rear for wall support
3096618140	SMIP2 Weather protection roof-130	AIP38915-10	Accessory	Weather protection roof width 130 mm for mounting on surface-mounted housing 1x1 to 1x5
3096618141	SMIP2 Weather protection roof-238	AIP38916-10	Accessory	Weather protection roof width 238 mm for mounting on surface-mounted housing 2x2 to 2x4

Article No.	Name	AIP No.	Module type	Description
Module frames, flush-mounted, cavity wall and surface-mounted boxes for GS series				
2921710051	SMIP2 GS-Module frame-1x1	AIP38961-07	Module frame	Module frame: 1x1 modules for mounting SMIP2 on enclosures of the GS system (cavity wall, surface-mounted, flush-mounted, pedestals)
2921710052	SMIP2 GS-Module frame-1x2	AIP38962-07	Module frame	Module frame: 1x2 modules for mounting SMIP2 on enclosures of the GS system (cavity wall, surface-mounted, flush-mounted, pedestals)
2921710053	SMIP2 GS-Module frame-1x3	AIP38963-07	Module frame	Module frame: 1x3 modules for mounting SMIP2 on enclosures of the GS system (cavity wall, surface-mounted, flush-mounted, pedestals)
2921710054	SMIP2 GS-Module frame-1x4	AIP38964-07	Module frame	Module frame: 1x4 modules for mounting SMIP2 on enclosures of the GS system (cavity wall, surface-mounted, flush-mounted, pedestals)
2921710055	SMIP2 GS-Module frame-1x5	AIP38965-07	Module frame	Module frame: 1x5 modules for mounting SMIP2 on enclosures of the GS system (cavity wall, surface-mounted, flush-mounted, pedestals)
10651831	GS-UP-1-A2	AIP38811-08	UP-Gehäuse	Flush-mounted housing GS design for 1 module for use with SMIP2 GS module frame-1x1
10651832	GS-UP-2-A2	AIP38812-08	UP-Gehäuse	Flush-mounted housing GS design for 1 module for use with SMIP2 GS module frame-1x2
10651833	GS-UP-3-A2	AIP38813-08	UP-Gehäuse	Flush-mounted housing GS design for 1 module for use with SMIP2 GS module frame-1x3
10651834	GS-UP-4-A2	AIP38814-08	UP-Gehäuse	Flush-mounted housing GS design for 1 module for use with SMIP2 GS module frame-1x4
10651809	GS-AP-1	AIP38811-09	UP-Gehäuse	Flush-mounted housing GS design for 1 module for use with SMIP2 GS module frame-1x5
10651810	GS-AP-2	AIP38812-09	UP-Gehäuse	Surface-mounted housing GS design for 2 modules for use with SMIP2 GS module frame 1x2
10651811	GS-AP-3	AIP38813-09	UP-Gehäuse	Surface-mounted housing GS design for 2 modules for use with SMIP2 GS module frame 1x3
10651812	GS-AP-4	AIP38814-09	UP-Gehäuse	Surface-mounted housing GS design for 2 modules for use with SMIP2 GS module frame 1x4
10651805	GS-HL-1	AIP38821-08	UP-Gehäuse	Cavity wall housing type GS for 1 module for use with SMIP2 GS module frame-1x1
10651806	GS-HL-2	AIP38822-08	UP-Gehäuse	Cavity wall housing type GS for 1 module for use with SMIP2 GS module frame-1x2
10651807	GS-HL-3	AIP38823-08	UP-Gehäuse	Cavity wall housing type GS for 1 module for use with SMIP2 GS module frame-1x3
10651808	GS-HL-4	AIP38824-08	UP-Gehäuse	Cavity wall housing type GS for 1 module for use with SMIP2 GS module frame-1x4

Important note for existing customers: GS module frames are the right frames if you want to replace your existing GS intercom stations (analog or IP) with SMIP2. This means you can continue to use your existing housings.

Services

Notes on assembly and calculation

You receive your ScanModul SMIP2 intercom stations fully assembled.
Please take the assembly rates below into account for your own calculation.

The assembly includes factory programming with standard parameters. If you require a project-specific pre-configuration, please order the corresponding item separately.

Article No.	Name	AIP No.	Module type	Description
Services				
2119440920	SMIP2 Assembly single module standard	-	Services	Assembly of a complete SMIP2 device, the rate is calculated per individual module
2119440937	SMIP2 Assembly single module powder coating	-	Services	Assembly of a SMIP2 device as powder-coated version, the rate is calculated per individual module
7819040007	Pre-configuration	-	Services	Pre-configuration with IP address and electronic test
2119440938	SMIP2 Powder coating complete unit RAL	-	Services	After coating, the intercom station is a fixed unit. Please specify: <ul style="list-style-type: none"> Coating structure: Fine structure or smooth finish Desired RAL color

Notes on grouping complete stations – important for your ordering and handling process

The following group articles are used for a convenient ordering and handling process. They are used to identify a complete intercom station in quotations, invoices and on packaging. The respective modules, accessories and services for this call station are listed individually under this group article.

If there are several call stations with different setups, each is assigned a group article. It is listed price-neutral with 0.00 Euro.

Use the group articles for your calculation to give it structure and ensure fast processing.

Article No.	Name	AIP No.	Module type	Description
Grouping of complete stations				
7997912005	SMIP2 complete unit-XS	-	Services	Intercom station consists of the following items. The individual modules are installed in the XS frame in the order listed from top to bottom.
7997912006	SMIP2 complete unit-XL	-	Services	Intercom station consists of the following items. The individual modules are installed in the XL frame in the order listed from top to bottom.
7997912007	SMIP2 complete unit-GS	-	Services	Intercom station consists of the following items. The individual modules are installed in the GS frame in the order listed from top to bottom.
7997912010	SMIP2 complete unit-GS powder-coated	-	Services	Intercom station consists of the following items. The individual modules are installed in the GS frame in the order listed from top to bottom and powder-coated.
7997912011	SMIP2 complete unit-HB	-	Services	Intercom station consists of the following items. The individual modules are installed from top to bottom in the rear frame (HB) in the order listed.

Get in touch with us – we are happy to provide you with an offer for your individual ScanModul SMIP2 intercom station!